

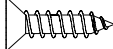

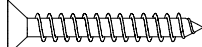







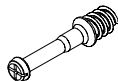
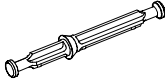

ACESSÓRIOS

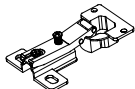
Código:	DESCRIÇÃO	QUANTIDADE
A	 Parafuso 4,0 x 12	66
B	 Parafuso 4,0 x 14	18
C	 Parafuso 4,5 x 35	25
D	 Cavilha 8 x 30	76
E	 Puxador	11
F 25	 Fixador de fundo	
G 44	 Pino Girofix	
H 4	 Pino Girofix Duplo	
I 52	 Castanha Girofix	
J 9	 Dobradiça / Calço	
K 2	 Sache de Cola	
L 99	 Pregão 10 x 10	
M 4	 Suporte Cabideiro	
N 8	 Suporte Prateleira / Bucha	
P 4	 Corrediça Telescópica	
Q 2	 Bastão	
R 4	 Cantoneira	

CUIDADOS ESPECIAIS COM A LIMPEZA

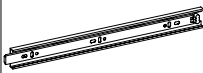
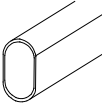
LIMPEZA MADEIRA: Pano limpo umedecido em água e sabão neutro - BRILHO: Flanela seca

Data atualização

07.05.2016

Somniare

Móveis Infante-Juvenis

Armário - LM 1106

ESQUEMA DE MONTAGEM

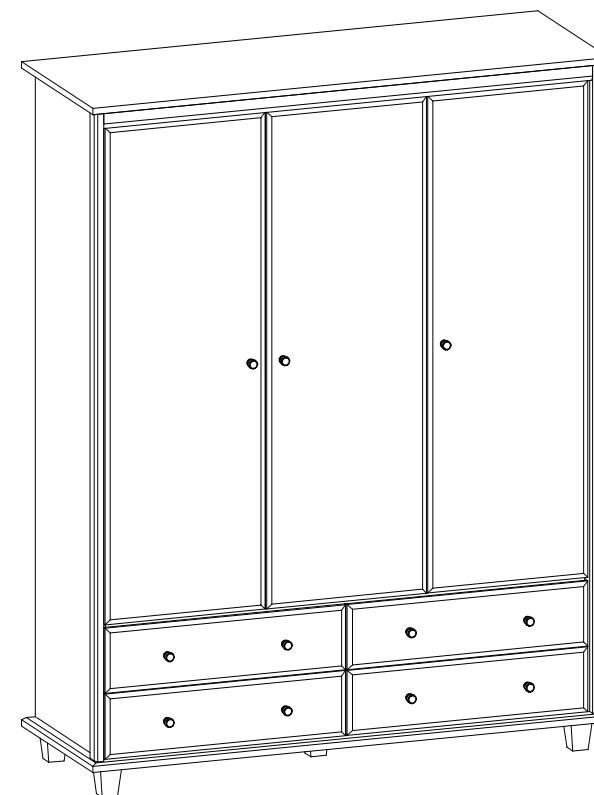

Ferramentas:

→ 1,685 m ↑ 2,185 m ↘ 0,600 m

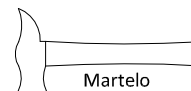

Martelo



Chave Fenda



Chave Philips

Quantidade de Montadores:

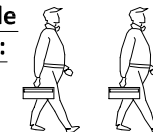

INSTRUÇÕES

- Prepare a montagem do móvel próximo ao local que ele ficará definitivamente e evite deslocá-lo depois de montado;
- Forre o chão com papelão ou similar e utilize a isomanta que vem entre as peças para evitar o contato entre elas durante a montagem;
- Monte o móvel obedecendo a ordem numérica da **sequência de montagem**, identificando as peças pelo **código de peça**.



Atendimento ao consumidor
tel +55 43 3256 0017
contato@kykmoveis.com.br

KYK Ind e Comércio Móveis Ltda.
Rua Ivai 275 | Parque Industrial
CEP 86600-000 | Rolândia | PR | Brasil
www.somniare.com.br

ADVERTÊNCIA

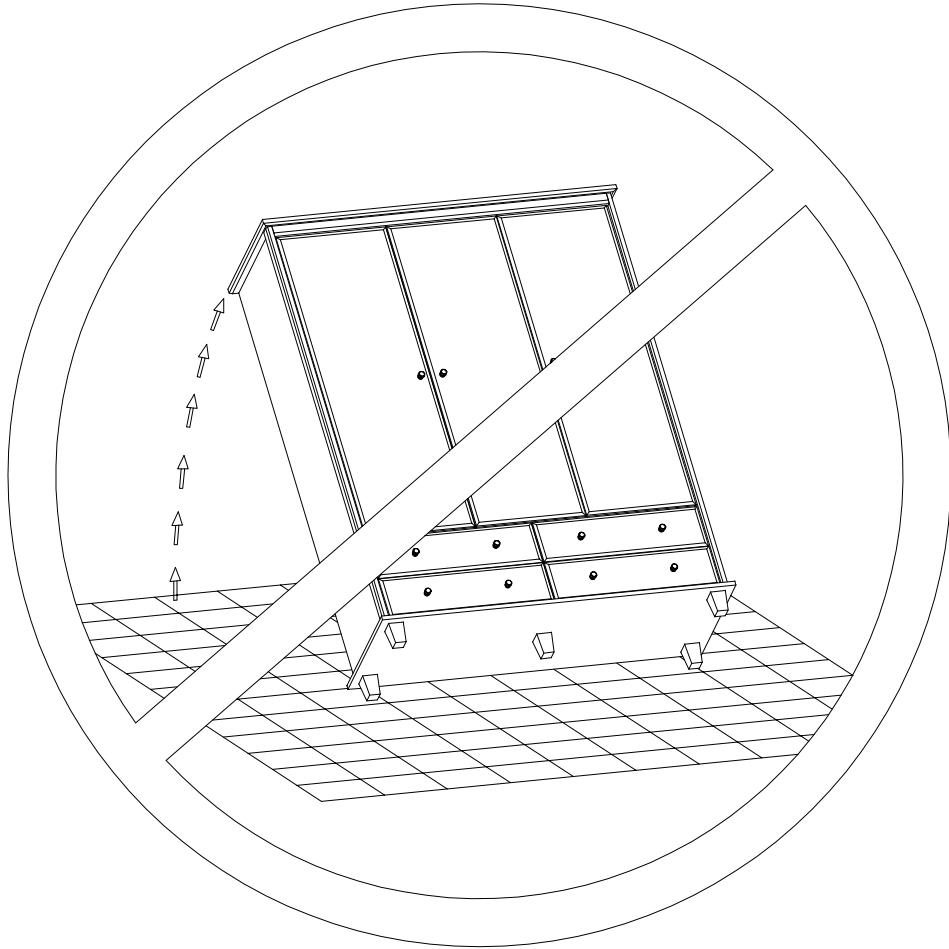

Montar o produto na posição vertical, pois caso contrário os pés poderão ser danificados ao levantar o produto.

6º PASSO

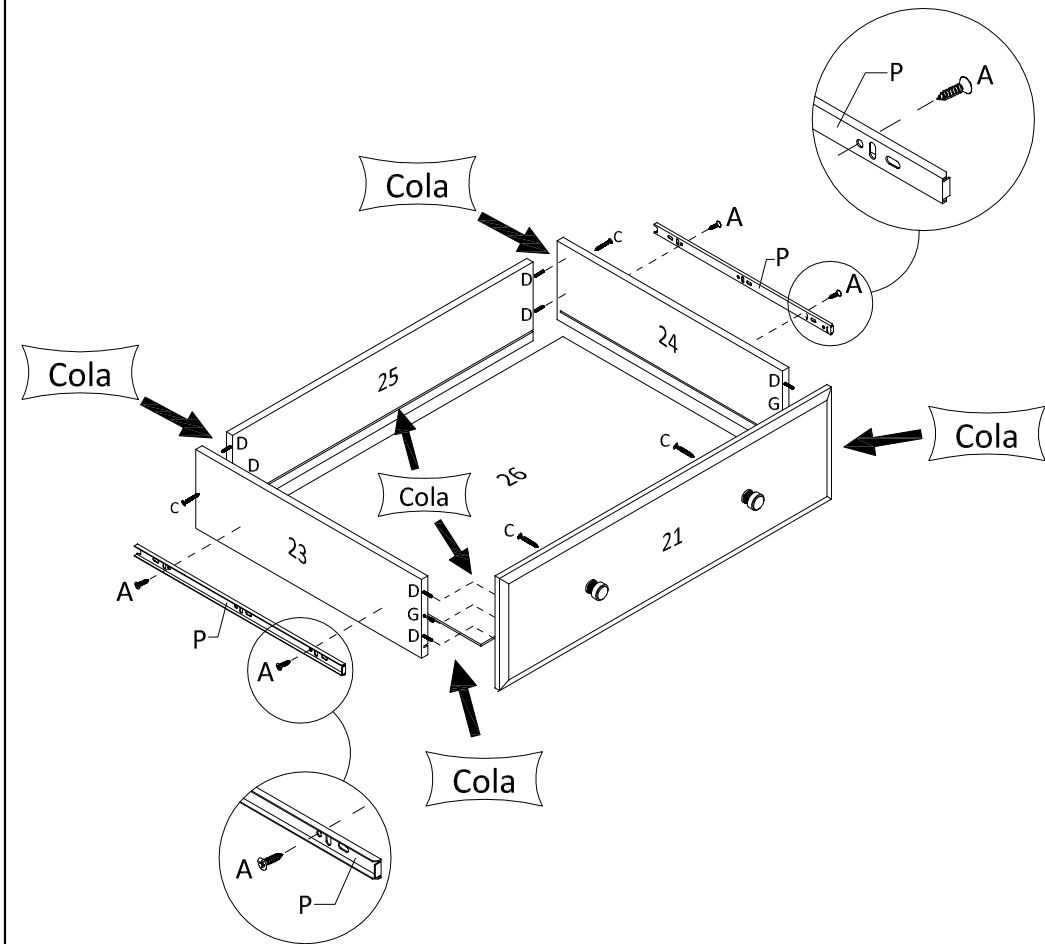

Sequência de Montagem	
Etapa	Código
1º	21
2º	23
3º	24
4º	26
5º	25

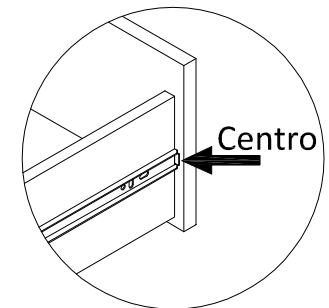

5º PASSO

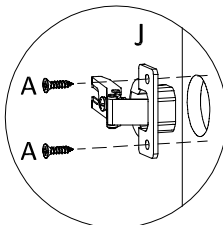
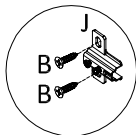
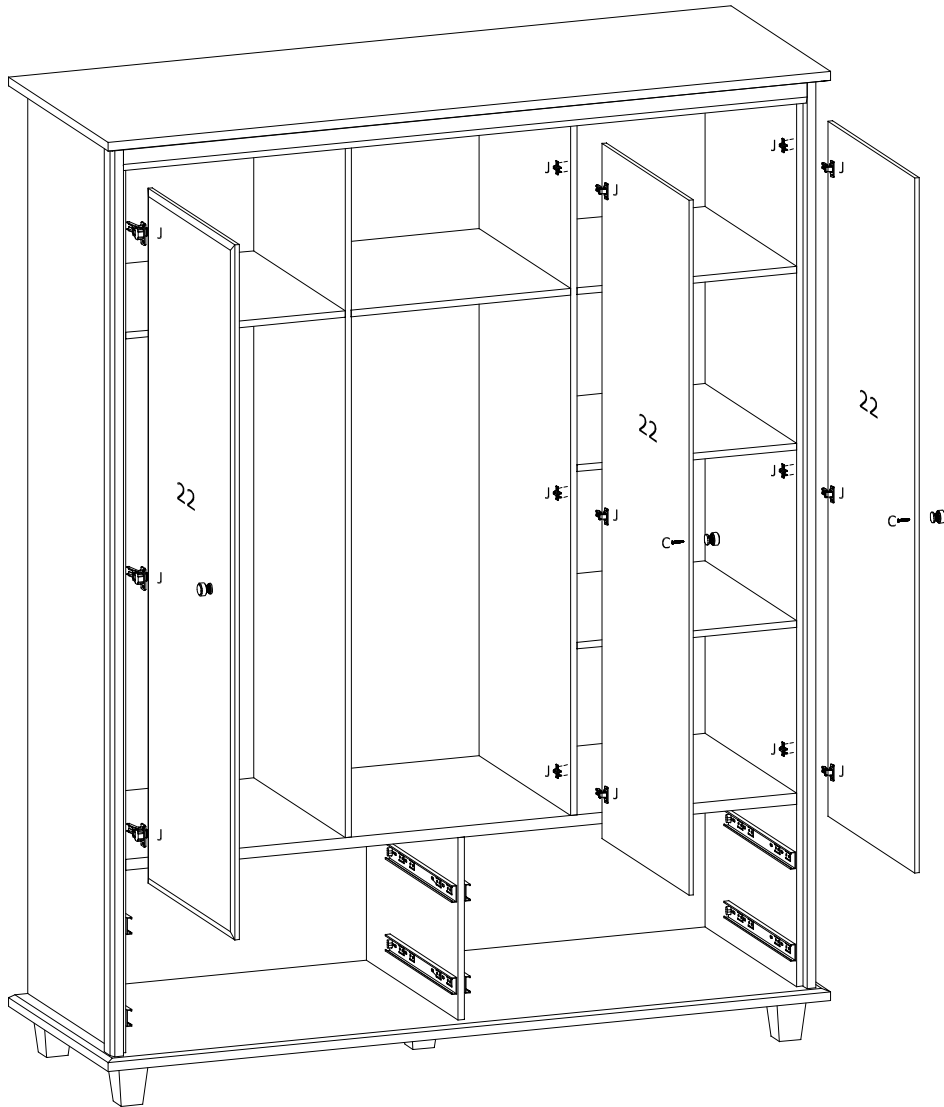

Sequência de Montagem

Etapa	Código
1º	22
2º	22
3º	22

CÓDIGO DE PEÇAS

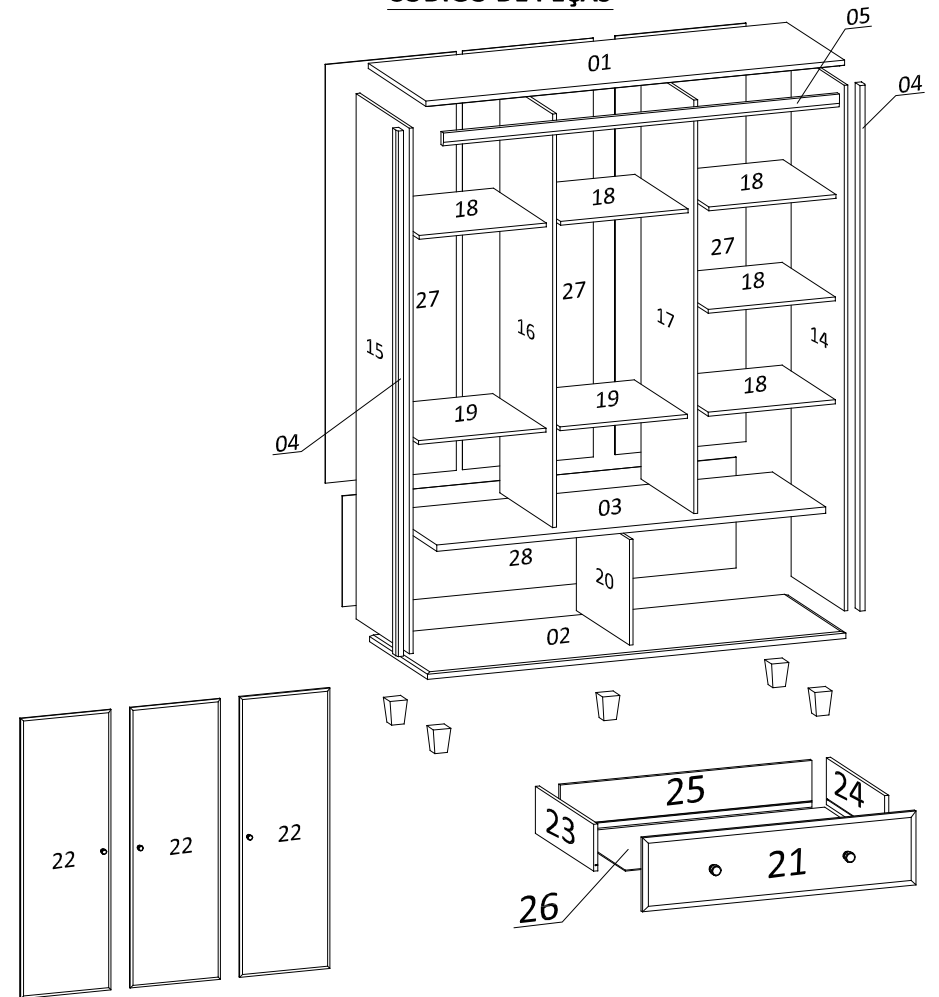

*Dimensões em metros

Código:	PEÇAS	DIMENSÕES*	QUANTIDADE
01	Tampo	1,685 x 0,600 x 0,025	1
02	Base	1,685 x 0,600 x 0,025	1
03	Tampo Intermediario	1,565 x 0,545 x 0,025	1
04	Moldura	2,040 x 0,050 x 0,025	2
05	Vista Superior	1,595 x 0,050 x 0,025	1
14	Lateral Direita	2,040 x 0,545 x 0,015	1
15	Lateral Esquerda	2,040 x 0,545 x 0,015	1
16	Divisão Vertical Esquerda	1,605 x 0,545 x 0,015	1
17	Divisão Vertical Direita	1,605 x 0,545 x 0,015	1
18	Prateleira Fixa	0,512 x 0,545 x 0,015	5
19	Prateleira Movel	0,510 x 0,540 x 0,015	2
20	Divisao Inferior	0,410 x 0,545 x 0,015	1
21	Frente Gaveta	0,785 x 0,205 x 0,015	4
22	Porta	1,563 x 0,522 x 0,015	3
23	Lateral Gaveta Esquerda	0,430 x 0,130 x 0,012	4
24	Lateral Gaveta Direita	0,430 x 0,130 x 0,012	4
25	Contra Fundo	0,726 x 0,130 x 0,012	4
26	Fundo Gaveta	0,740 x 0,430 x 0,003	4
27	Fundo Porta	1,625 x 0,527 x 0,003	3
28	Fundo Inferior	1,585 x 0,430 x 0,003	1

1º PASSO

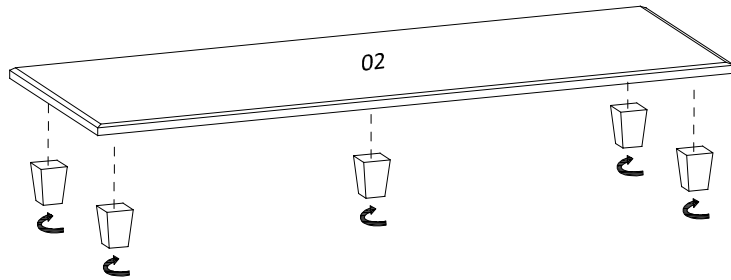

Montar o produto em pé, para que não danifique os pés quando for levantar.

2º PASSO

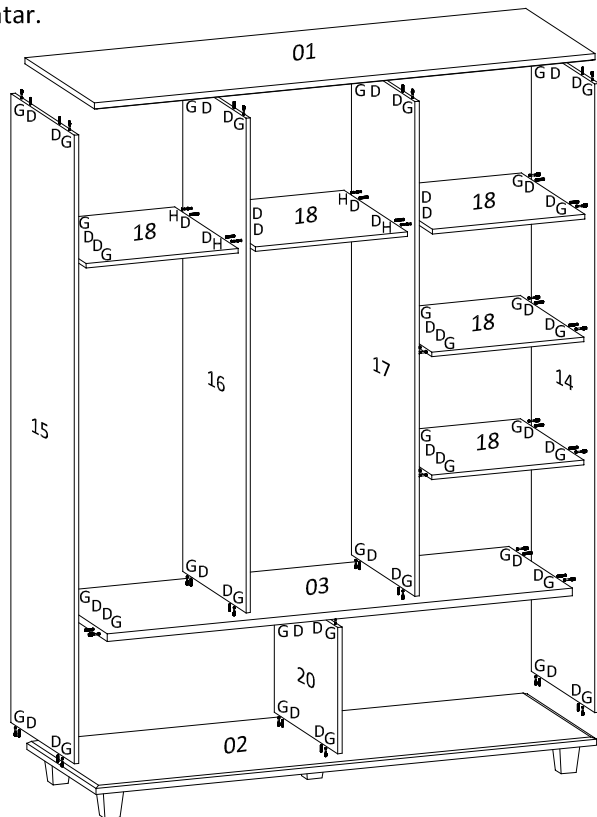

Sequência de Montagem

Etapa	Código
1º	02
2º	15
3º	20
4º	03
5º	14
6º	18
7º	18
8º	18
9º	17
10º	18
11º	16
12º	18
13º	01

Sequência de Montagem

Etapa	Código
1º	28
2º	27
3º	27
4º	27

3º PASSO

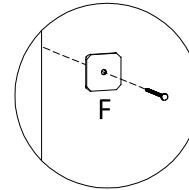
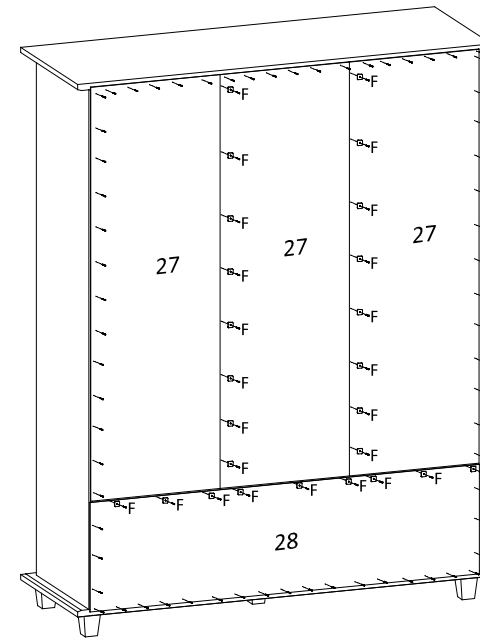

4º PASSO

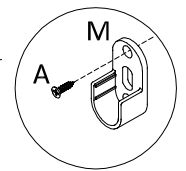
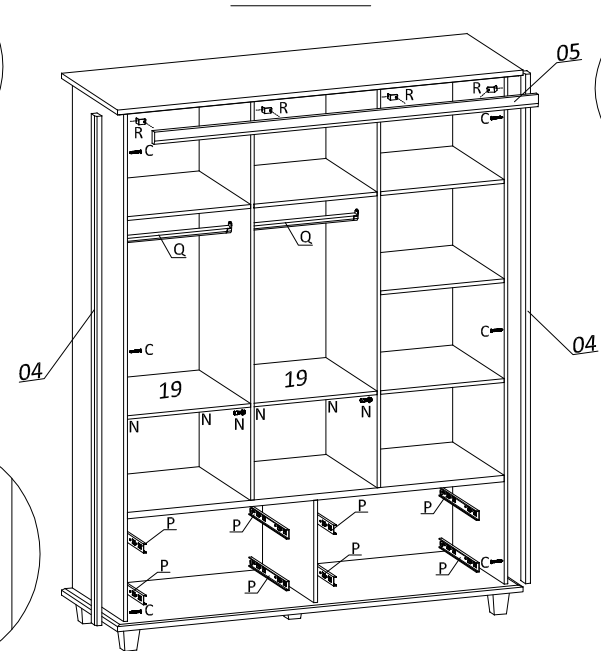
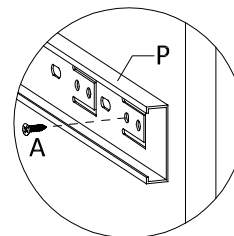
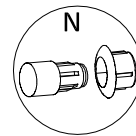
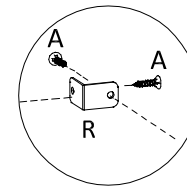

Sequência de Montagem

Etapa	Código
1º	05
2º	04
3º	04
4º	19
5º	19